

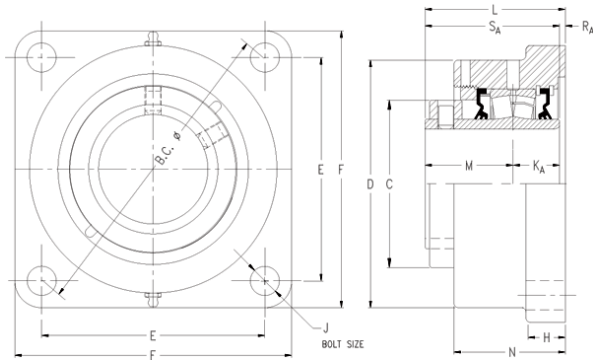

SAF BEARING LIMITED



timken QAF13A208S Solid Block/Spherical Roller Bearing Housed Units-Single Concentric Four Bolt Square Flange Block

Bearing No. QAF13A208S

QAF13A208S Bearing 2D drawings and 3D CAD models

Engineering Group	Mounted Bearing
Shaft Size	2-1/2 in
Shaft Size Type	Imperial
Full Timken Part Number	QAF13A208SB
Locking Style	Single Concentric
Weight	17.0 lb
Housing Style	Four-Bolt Square Flange
UPC Code	0883450038508
Dimension BC	7.6 in
Dimension C	4 in
Dimension D	5.750 in
Dimension E	5.38 in
Dimension F	6.63 in
Dimension H	1.00 in
Dimension J (Bolt Size)	0.625 in
Dimension KA	1.24 in
Dimension L Exp	3.59 in
Dimension L Fix	3.51 in
Dimension M	2.15 in
Dimension N	2.850 in
Dimension RA	0.12 in
Dimension SA	3.39 in
C0 - Static Load	48600 lb
C - Dynamic Load (Basic)	46400 lb
e - Geometry Factor	0.25



SAF BEARING LIMITED

Y1 - Geometry Factor	2.69
Y2 - Geometry Factor	4.00
Oil Lubrication - M/N Seal	1800 rpm
Oil Lubrication - T Seal	3200 rpm
Oil Lubrication - B/C/O Seal	1500 rpm
Grease Lubrication - M/N Seal	1800 rpm
Grease Lubrication - T Seal	2800 rpm
Grease Lubrication - B/C/O Seal	1500 rpm
Float	0.083 in
Shaft Tolerance	0.0015 in
Eng Internal Radial Clearance - Min	0.0016
Eng Internal Radial Clearance - Max	0.0026
Pre Install Clearance Min	0.0016 in
Pre Install Clearance Max	0.0026 in