

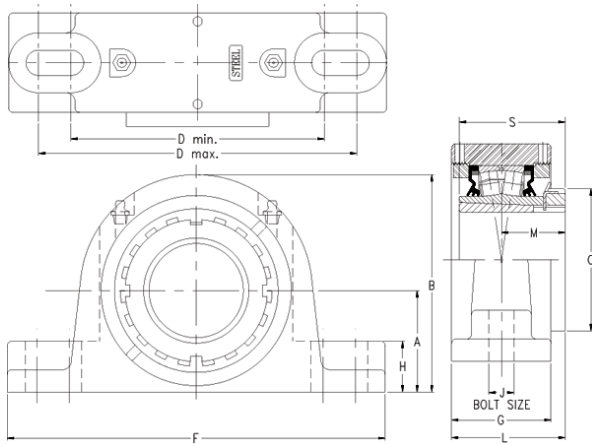

SAF BEARING LIMITED



timken TAPA13K204S Solid Block/Spherical Roller Bearing Housed Units-Tapered Adapter Two-Bolt Pillow Block

Bearing No. TAPA13K204S

Engineering Group	Mounted Bearing
Shaft Size	2-1/4 in
Shaft Size Type	Imperial
Full Timken Part Number	TAPA13K204SB
Locking Style	Tapered Adapter
Weight	23 lb
Housing Style	Two-Bolt Pillow Block
UPC Code	0883450124874
Dimension A	3.00 in
Dimension B	5.95 in
Dimension C	3.35 in
Dimension D Max	9.20 in
Dimension D Min	7.20 in
Dimension F	10.31 in
Dimension G	2.700 in
Dimension H	1.23 in
Dimension J (Bolt Size)	0.625 in
Dimension L	2.91 in
Dimension M	1.56 in
Dimension S	2.56 in
C0 - Static Load	48600 lb
C - Dynamic Load (Basic)	46400 lb
e - Geometry Factor	0.24
Y1 - Geometry Factor	2.79
Y2 - Geometry Factor	4.15

TAPA13K204S Bearing 2D drawings and 3D CAD models



SAF BEARING LIMITED

Oil Lubrication - M/N Seal	1800 rpm
Oil Lubrication - T Seal	3200 rpm
Oil Lubrication - B/C/O Seal	1500 rpm
Grease Lubrication - M/N Seal	1800 rpm
Grease Lubrication - T Seal	2800 rpm
Grease Lubrication - B/C/O Seal	1500 rpm
Float	0.050 in
Shaft Tolerance	0.0030 in
Pre Install Clearance Min	0.0030 in
Pre Install Clearance Max	0.0037 in
Int Radial Clearance Reduction Min	0.0012 in
Int Radial Clearance Reduction Max	0.0015 in
Adapter Sleeve Axial Movement Min	0.018 in
Adapter Sleeve Axial Movement Max	0.022 in
Post Install Int Radial Clearance Min	0.0015 in