

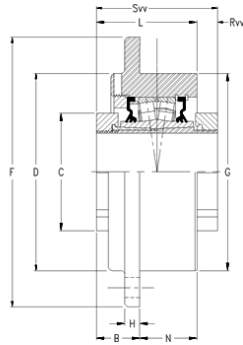

SAF BEARING LIMITED

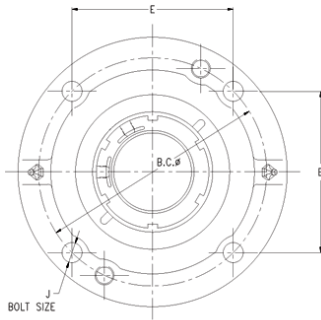

timken QVVC22V312S Solid Block/Spherical Roller Bearing Housed Units-Double V-Lock Piloted Flange Cartridge

Bearing No. QVVC22V312S

QVVC22V312S Bearing 2D drawings and 3D CAD models

Engineering Group	Mounted Bearing
Shaft Size	3-3/4 in
Shaft Size Type	Imperial
Full Timken Part Number	QVVC22V312SB
Locking Style	Double V-Lock
Weight	43 lb
Housing Style	Piloted Flange Cartridge
UPC Code	0883450090964
Dimension BC	9.38 in
Dimension C	5.5000 in
Dimension E	6.63 in
Dimension B Fix	2.37 in
Dimension B Exp	2.45 in
Dimension F	10.88 in
Dimension D	8.76 in
Dimension H	1.00 in
Dimension J (Bolt Size)	0.75 in
Dimension L	4.54 in
Dimension RVV	0.46 in
Dimension SVV	4.99 in
Dimension G	8.125 in
Dimension N	2.13 in
C - Dynamic Load (Basic)	125000 lb
C0 - Static Load	147000 lb
e - Geometry Factor	0.25



SAF BEARING LIMITED

Y1 - Geometry Factor	2.73
Y2 - Geometry Factor	4.06
Oil Lubrication - M/N Seal	900 rpm
Oil Lubrication - T Seal	1700 rpm
Oil Lubrication - B/C/O Seal	600 rpm
Grease Lubrication - M/N Seal	900 rpm
Grease Lubrication - T Seal	1200 rpm
Grease Lubrication - B/C/O Seal	600 rpm
Float	0.083 in
Shaft Tolerance	0.0030 in
Eng Internal Radial Clearance - Min	0.0053
Eng Internal Radial Clearance - Max	0.0067
Pre Install Clearance Min	0.0053 in
Pre Install Clearance Max	0.0067 in