

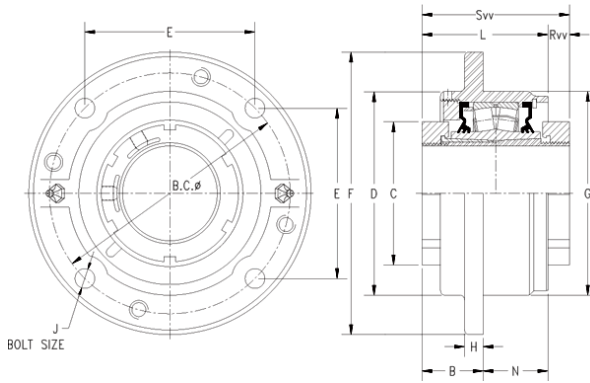

SAF BEARING LIMITED



timken QVVCW11V115S Solid Block/Spherical Roller Bearing Housed Units- Double V-Lock Piloted Flange Cartridge

Bearing No. QVVCW11V115S

QVVCW11V115S Bearing 2D drawings and 3D CAD models

Engineering Group	Mounted Bearing
Shaft Size	1-15/16 in
Shaft Size Type	Imperial
Full Timken Part Number	QVVCW11V115SB
Locking Style	Double V-Lock
Weight	10 lb
Housing Style	Piloted Flange Cartridge
UPC Code	0883450091329
Dimension BC	5.38 in
Dimension C	2.990 in
Dimension E	3.80 in
Dimension B Fix	1.66 in
Dimension B Exp	1.74 in
Dimension F	6.38 in
Dimension D	4.47 in
Dimension H	0.38 in
Dimension J (Bolt Size)	0.438 in
Dimension L	3.16 in
Dimension RVV	0.86 in
Dimension SVV	4.02 in
Dimension G	4.500 in
Dimension N	1.50 in
C - Dynamic Load (Basic)	31400 lb
C0 - Static Load	31900 lb
e - Geometry Factor	0.23



SAF BEARING LIMITED

Y1 - Geometry Factor	2.95
Y2 - Geometry Factor	4.40
Oil Lubrication - M/N Seal	2200 rpm
Oil Lubrication - T Seal	3800 rpm
Oil Lubrication - B/C/O Seal	1800 rpm
Grease Lubrication - M/N Seal	2200 rpm
Grease Lubrication - T Seal	3200 rpm
Grease Lubrication - B/C/O Seal	1600 rpm
Float	0.050 in
Shaft Tolerance	0.0015 in
Eng Internal Radial Clearance - Min	0.0030
Eng Internal Radial Clearance - Max	0.0037
Pre Install Clearance Min	0.0030 in
Pre Install Clearance Max	0.0037 in