

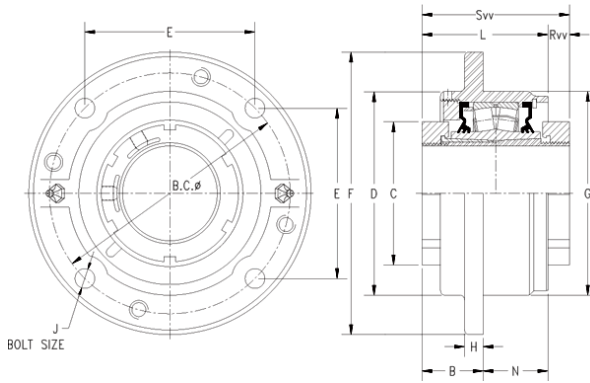

SAF BEARING LIMITED



timken QVVCW14V065S Solid Block/Spherical Roller Bearing Housed Units- Double V-Lock Piloted Flange Cartridge

Bearing No. QVVCW14V065S

QVVCW14V065S Bearing 2D drawings and 3D CAD models

Engineering Group	Mounted Bearing
Shaft Size	65 mm
Shaft Size Type	Metric
Full Timken Part Number	QVVCW14V065SB
Locking Style	Double V-Lock
Weight	16 lb
Housing Style	Piloted Flange Cartridge
UPC Code	0883450063517
Dimension BC	6.50 in
Dimension C	3.700 in
Dimension E	4.60 in
Dimension B Fix	1.65 in
Dimension B Exp	1.73 in
Dimension F	7.63 in
Dimension D	5.50 in
Dimension H	0.50 in
Dimension J (Bolt Size)	0.5 in
Dimension L	3.40 in
Dimension RVV	0.59 in
Dimension SVV	3.99 in
Dimension G	5.500 in
Dimension N	1.69 in
C - Dynamic Load (Basic)	47800 lb
C0 - Static Load	52000 lb
e - Geometry Factor	0.23



SAF BEARING LIMITED

Y1 - Geometry Factor	2.90
Y2 - Geometry Factor	4.32
Oil Lubrication - M/N Seal	1700 rpm
Oil Lubrication - T Seal	3050 rpm
Oil Lubrication - B/C/O Seal	1400 rpm
Grease Lubrication - M/N Seal	1700 rpm
Grease Lubrication - T Seal	2600 rpm
Grease Lubrication - B/C/O Seal	1400 rpm
Float	0.083 in
Shaft Tolerance	0.0015 in
Pre Install Clearance Min	0.0030 in
Pre Install Clearance Max	0.0037 in